

















**230x280 A-CNC-R 27x0,9**

	 0°	 45°	 60°	 45°	 60°	 $\begin{matrix} b \\ a \times b \end{matrix}$
	230	180	110	x	x	x
	280x200	180x170	100x70	x	x	280x120
						
3x400V 50 Hz	1,5	20-100	2720x27x0,9	780		
<b>L</b>	<b>B</b>	<b>Hmin</b>	<b>Hmax</b>	<b>V</b>		
2305	2260	1405	1780	800		



STANDARD    OPTION

230-F

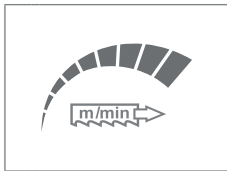

230-PUD

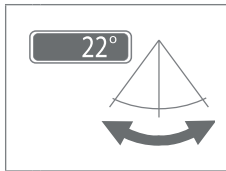

240-CK

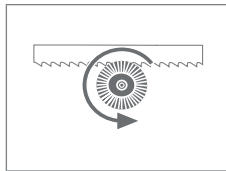

230-DPP

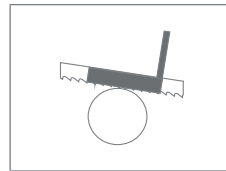

PEGAS-BRP

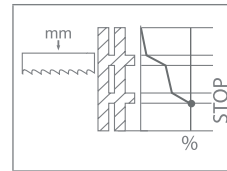

LASER LINE

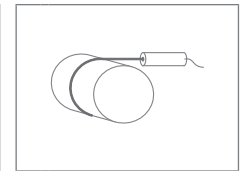

230-HP-A

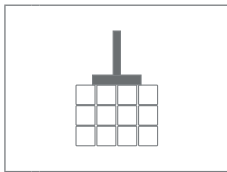

MINI LUBE 27-34

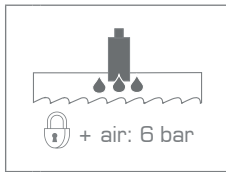

R 290

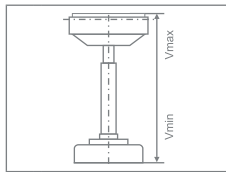

LIGHT L1

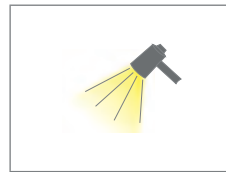

MITSUBISHI HMI 7"

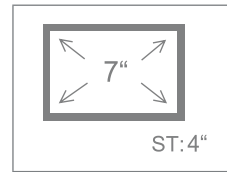

230-RTS-A

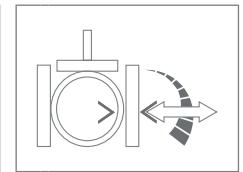

RB 200



RBS 200/290  
+RB

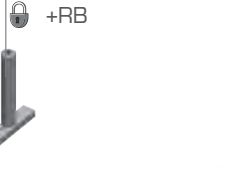

RHS 290  
+RBS+RB



230-VTT



RD 1000/290



RD 2000/290



BOX-PCS

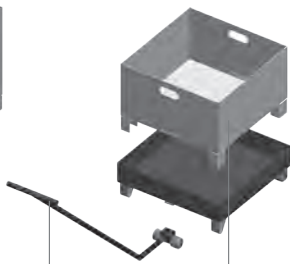

BOX-TAH

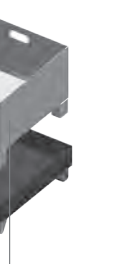

BOX-TRI



RD 1000/290

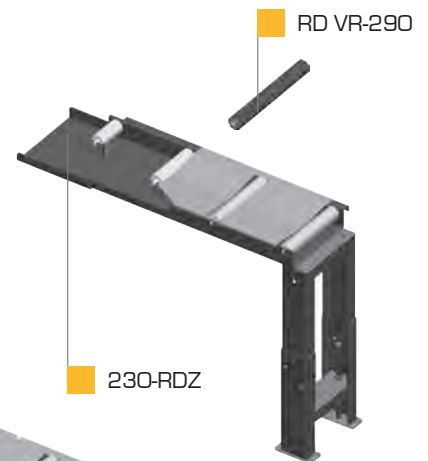

RD VR-290

230-RDZ



RDN



CONTROL PANEL: MITSUBISHI NC

## 230x280 A-CNC-R

- výrobce si vyhrazuje právo provádět změny technických údajů, technické údaje odpovídají 1.1.2023 / producer has the right to make changes of technical data, technical data are valid on 1.1.2023

- pila na fotografii není vždy v základním provedení, uvedené rozměry odpovídají stroji v základním provedení / the machine in the picture is not always in the basic version, mentioned diameters are for machine in basic version

\* doporučená hodnota. Při překročení doporučeného maximálního průměru není možné garantovat výkon pilového pásu!

/ recommended value. The blade performance cannot be guaranteed when the recommended diameter is exceeded!

☒ - řezání svazků bez horního přitlačku / cutting of the bundle without top clamping



PEGAS - GONDA s.r.o.  
Čs.armády 322, 684 01 Slavkov u Brna,  
CZECH REPUBLIC

www.pegas-gonda.cz  
00420-544 221 125 (126) | pegas@gonda.cz